

F-1 车架 Frame Assy

PHOTO	NO.	Part CODE	Chinese/English name and specification		UNIT	QTY
	1	360006-T500-00000	车架焊接总成	Frame Assy	PIECE	1
	2	350008-T500-00000	ABS支架	Bracket, ABS	PIECE	1
	3	420008-T501-00008	工字胶圈10*14*20	Ring, Rubber I-Shaped 10*14*20	PIECE	2
	4	5001-06016-SC00	六角法兰面螺栓M6*16	Bolt, Hex. Flange	PIECE	2
	5	5001-08020-SC00	六角法兰面螺栓M8*20	Bolt, Hex. Flange	PIECE	4
	6	360040-T501-00000	发动机上悬挂-右	Engine upper suspension - right	PIECE	1
	7	360039-T501-00000	发动机上悬挂-左	Engine upper suspension - left	PIECE	1
	8	5008-08085-SC00	六角法兰面自锁螺母M8	Tapping Nut, Hex. Flange M8*1.25	PIECE	2
	9	360077-T501-00000	喇叭支架	Horn Bracket	PIECE	1
	10	360037-T501-00000	发动机前悬挂-左	EngineFront Suspension - left	PIECE	1
	11	360038-T501-00000	发动机前悬挂-右	Engine front suspension- right	PIECE	1
	12	5021-08115-DK00	内六花六角法兰面螺栓M8*115	Bolt, Hex. Flange	PIECE	2
	13	910004-T501-00002	衬套 $\phi 10.5 * \phi 20 * 26.5$ (发动机下悬挂 衬套-右)	Lower Engine Suspension Bushing-	PIECE	1
	14	910004-P200-00002	衬套 $\phi 10.5 * \phi 24 * 5$ (发动机下悬挂衬 套-左)	Bushing $\phi 10 * \phi 24 * 5$	PIECE	1
	15	5015-03010-SC00	铆钉3.2*10	Rivet 3.2*10	PIECE	2
	16	900001-R100-000	车架铭牌	Frame nameplate	PIECE	1
	17					
	18					
	19					
	20					

F-2 方向柱 Steering column							
PHOTO	NO.	Part CODE	Chinese/English name and specification		UNIT	QTY	
	1	5001-14030-YH00	六角法兰面螺栓M14*1.5*30	Bolt, Hex. Flange M14*1.5*30	PIECE	1	
	2	5018-15010-SC00	平垫 $\phi 15 * \phi 33 * 1$	Washer, Flat $\phi 15 * \phi 33 * 1$	PIECE	1	
	3	5021-08035-DK00	内六花六角法兰面螺栓M8*35	Bolt, Hex. Flange	PIECE	4	
	4	370020-T500-00000	上连接板	Connecting Plate, Upper	PIECE	1	
	5	350012-T500-00000	上连接线钩	Clip, Upper Connecting Plate	PIECE	1	
	6	5021-06012-DK00	内六花六角法兰面螺栓M6*12	Bolt, Hex. Flange M6*12	PIECE	2	
	7	350025-T501-00000	油管卡子	Oil pipe clip	PIECE	1	
	8	5021-08040-DK00	内六花六角法兰面螺栓M8*40	Bolt, Hex. Flange	PIECE	4	
	9	370102-T501-00000	下连接板	Connecting Plate, Lower	PIECE	1	
	10	370101-T501-00000	方向柱	Steering Column	PIECE	1	
	11	5010-25100-YH00	4槽调节螺母	Nut, Adjustable 4 Groove	PIECE	1	
	12	371100-R100-00001	方向柱上防尘盖	Upper Cap, Steering Column Anti-Dust	PIECE	1	
	13	370600-R100-000	方向上轴承	Bearing, Steering Column Upper	PIECE	1	
	14	370700-R100-000	方向下轴承	Bearing, Steering Column Lower	PIECE	1	
	15	371200-R100-00001	方向柱下防尘盖	Lower Cap, Steering Column Anti-Dust	PIECE	1	
	16						
	17						
	18						
	19						
	20						

F-3 平叉-1 Flat fork-1

PHOTO	NO.	Part CODE	Chinese/English name and specification		UNIT	QTY
	1	410002-T501-00000	平叉轴	Axle, Rear Arm	PIECE	1
	2	5103-303704-000	油封 $\phi 30 * \phi 37 * 4$	Oil Seal $\phi 30 * \phi 37 * 4$	PIECE	2
	3	910014-T501-00000	T型轴套 $\phi 17 * \phi 22 * 40$	T-bush $\phi 17 * \phi 22 * 40$	PIECE	2
	4	5106-223603-BS0	推力轴承 $\phi 22.2 * \phi 36.5 * 3.6$	Thrust Bearing $\phi 22.2 * \phi 36.5 * 3.6$	PIECE	2
	5	5102-222930-BS0	滚针轴承 $\phi 22 * \phi 29 * 30$	Needle Bearing $\phi 22 * \phi 29 * 30$	PIECE	2
	6	5103-222904-000	油封 $\phi 22 * \phi 29 * 4$	Oil Seal $\phi 22 * \phi 29 * 4$	PIECE	2
	7	420019-R201-000	平叉防尘盖	Rear Arm, Anti-dust	PIECE	3
	8	5018-17025-BS00	平垫 $\phi 17 * \phi 32 * 2.5$	Washer, Flat $\phi 17 * \phi 32 * 2.5$	PIECE	1
	9	5010-16110-BS00	前轮轴螺母M16*1.5*11	Nut, Front wheel axle M16*1.5	PIECE	1
	10	360300-T501-00000	平叉	Rear Arm	PIECE	1
	11	370012-T501-00000	链条调节器-右	Chain Adjuster (Right)	PIECE	1
	12	5008-08065-SC00	六角螺母M8	Bolt, Hex M8	PIECE	2
	13	5002-08055-JL00	六角螺栓M8*55	Hex Bolt M8*55	PIECE	2
	14	370011-T501-00000	链条调节器-左	Chain Adjuster (Left)	PIECE	1
	15	360026-T501-00000	导链器	Chain Guide	PIECE	1
	16	5008-06070-SC00	六角法兰面螺母M6	Nut, Hex. Flange M6	PIECE	2
	17	5021-06048-DK00	内六花六角法兰面螺栓M6*48	Bolt, Hex. Flange	PIECE	2
	18	5021-06012-DK00	内六花六角法兰面螺栓M6*12	Bolt, Hex. Flange M6*12	PIECE	1
	19	420059-T501-00000	导链器橡胶块	Rubber Blocks, Chain guide	PIECE	1
	20	420059-T501-00001	导链器橡胶块	Rubber Block, Chain guide	PIECE	1

F-2 平叉-3 Flat fork-2

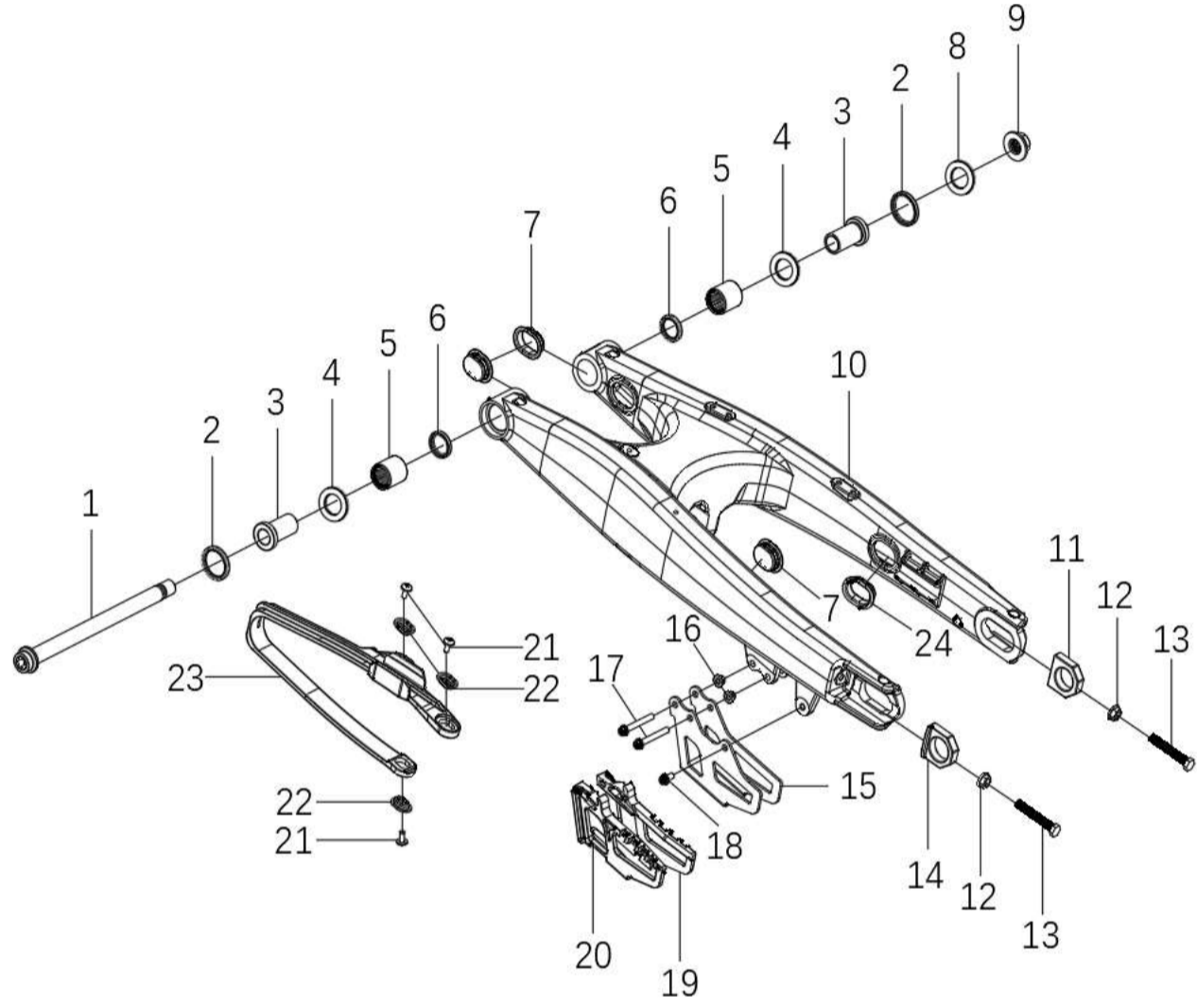
PHOTO	NO.	Part CODE	Chinese/English name and specification	UNIT	QTY	
	21	5005-06012-BS00	十字盘头螺钉M6*12	Screw, Cross-Shaped, Cup Head	PIECE	3
	22	420018-R100-000	链条护卡压板	Protecting Plate Press Plate, Chain	PIECE	3
	23	370017-T501-00000	链条护卡	Bolt, Hex. Flange	PIECE	1
	24	420019-R201-00001	平叉防尘盖	Rear Arm, Anti-dust	PIECE	1
	25					
	26					
	27					
	28					
	29					
	30					
	31					
	32					
	33					
	34					
	35					
	36					
	37					
	38					
	39					
	40					

F-4 后减震器&摇架-1 Rear shock absorber & Cradle-1

PHOTO	NO.	Part CODE	Chinese/English name and specification	UNIT	QTY
	1	5021-10052-DK00	内六花六角法兰面螺栓M10*52 Bolt, Hex. Flange M10x52	PIECE	1
	2.2	371500-T500-00001	后减震器(标准版-渝安减震) Rear shock absorber (Standard version - Yu'an Shock Absorber)	PIECE	1
	2.4	371500-T501-00001	后减震器(高座版-渝安减震) Rear Shock Absorber (YU' AN Absorber)	PIECE	1
	3	5008-08065-SC00	六角螺母M8 Bolt, Hex M8	PIECE	1
	4	5018-08516-LB01	平垫 $\phi 8.5 * \phi 18 * 1.6$ Washer, Flat	PIECE	1
	5	360800-T501-00000	导链轮总成 Guide Sprocket Assembly	PIECE	1
	6	5007-10061-SC00	导链轮螺栓M10*61(六角厚度8,总长61,内孔M10*16,螺杆M8*36.5,台阶 $\phi 16$) Bolt, Guide sprocket	PIECE	1
	7	5103-222804-000	油封 $\phi 22 * \phi 28 * 4$ Oil Seal $\phi 22 * \phi 28 * 4$	PIECE	2
	8	5013-10005-SC01	翻边衬套 $\phi 10.1 * \phi 22 * 5$ Bushing, Flange $\phi 10.1 * \phi 22 * 5$	PIECE	2
	9	5018-18015-SC01	平垫 $\phi 18.1 * \phi 27 * 1.5$ Washer, Flat	PIECE	2
	10	5102-172420-BS0	滚针轴承 $\phi 17 * \phi 24 * 20$ Needle Bearing $\phi 17 * \phi 24 * 20$	PIECE	2
	11	360008-T501-00001	U型摇架 U-shaped Rocker	PIECE	1
	12	910016-T501-00001	U型摇架轴套 $\phi 10 * \phi 17 * 87.5$ U-shaped Rocker Bushing $\phi 10 * \phi 17 * 87.5$	PIECE	1
	13	5001-10130-DK01	六角法兰面螺栓 M10*1.25*130 Bolt, Hex. Flange M10*1.25*130	PIECE	1
	14	5008-10115-SC00	六角法兰面自锁螺母M10*1.25 Tapping Nut, Hex. Flange M10*1.25	PIECE	1
	15	5103-172603-000	油封 $\phi 17.5 * \phi 26 * 3$ Oil Seal $\phi 17.5 * \phi 26 * 3$	PIECE	2
	16	360007-T501-00000	三角摇架 Triangle Rocker	PIECE	1
17	910015-T501-00001	三角摇架轴套 $\phi 12 * \phi 20 * 37$ Triangle Rocker Bushing $\phi 12 * \phi 20 * 37$	PIECE	1	

F-4 后减震器&摇架-2 Rear shock absorber & Cradle-2

PHOTO	NO.	Part CODE	Chinese/English name and specification	UNIT	QTY	
	18	910015-T501-00003	三角摇架轴套 $\phi 14* \phi 19*10.6$ Triangle Rocker Bushing $\phi 14* \phi 19*10.2$	PIECE	1	
	19	5102-192613-BS0	滚针轴承 $\phi 19* \phi 26*13$ Needle Bearing $\phi 19* \phi 26*13$	PIECE	1	
	20	5007-10045-DK00	扁头螺栓M10*45 Gib-headed Bolt M10*45	PIECE	1	
	21	5007-12085-DK00	扁头螺栓M12*85 Gib-headed Bolt M12*85	PIECE	1	
	22	5008-12125-SC00	六角法兰面自锁螺母M12*1.25 Tapping Nut, Hex. Flange M12*1.25	PIECE	2	
	23	5103-253204-000	油封 $\phi 25* \phi 32*4$ Oil Seal $\phi 25* \phi 32*4$	PIECE	4	
	24	5013-12005-SC00	翻边衬套 $\phi 12.1* \phi 25*5$ Bushing, Flange $\phi 12.1* \phi 25*5$	PIECE	4	
	25	5018-20115-SC00	平垫 $\phi 20.1* \phi 31*1.5$ Washer, Flat $\phi 20.1* \phi 31*1.5$	PIECE	4	
	26	5102-202615-BS0	滚针轴承 $\phi 20* \phi 26*15$ Needle Bearing $\phi 20* \phi 26*15$	PIECE	4	
	27	910015-T501-00000	三角摇架轴套 $\phi 12* \phi 20*61.5$ Triangle Rocker Bushing $\phi 12* \phi 20*61.5$	PIECE	1	
	28	5007-12105-DK00	扁头螺栓M12*105 Gib-headed Bolt M12*105	PIECE	1	
	29	910017-T501-00001	翻边轴承套 $\phi 10* \phi 14*7.2$ Bushing, Flange $\phi 10* \phi 14*7.2$	PIECE	2	
	30					
	31					
	32					
	33					
	34					
35						
36						
37						

F-5 前网轮 Front net wheel					
PHOTO	NO.	Part CODE	Chinese/English name and specification		UNIT QTY
	1	350027-T500-00000	前轮外胎	Front OuterTire	PIECE 1
	2	350026-T501-00000	前轮内胎(含气门嘴盖及锁紧螺母)	Inner tube of front wheel (including valve nozzle cover and locking nut)	PIECE 1
	3	352000-T500-00001	前网轮总成	Spoke WheelAssy, Front	PIECE 1
	4	350028-T501-00000	前轮垫带	Front Wheel Cushion	PIECE 1
	5	351700-T501-00000	前碟刹盘	Brake Disc (Front)	PIECE 1
	6	5021-06012-DK00	内六花六角法兰面螺栓M6*12	Bolt, Hex. Flange M6*12	PIECE 6
	7	350023-T500-00000	ABS齿圈-前	ABS Gear Ring(Front)	PIECE 1
	8	5014-05008-BS00	内六角沉头螺钉M5*8	Screw, Inner Hex. Countersunk Head	PIECE 3
	9.1	410001-T501-00000	前轮轴(长轴, 配KYB减震器, 长度238)	Axle, Wheel(Front) (KYB Shock Absorber, length, 238)	PIECE 1
	9.2	410001-T501-00001	前轮轴(短轴, 配渝安减震器, 长度229)	Axle, Wheel(Front) (Yu'an Shock)	PIECE 1
	10	5010-16110-SC00	前轮轴螺母M16*1.5*11	Axle Nut, Front wheel	PIECE 1
	11	5104-028015-000	O型圈 $\phi 28*1.5$	O-ring	PIECE 1
	12	350041-T500-00000	前轮速传感器支架	Bracket, Front Wheel Speed Sensor	PIECE 1
	13	5103-273707-000	油封 $\phi 27*\phi 37*7$	Oil Seal $\phi 27*\phi 37*7$	PIECE 2
	14	910012-T501-00002	前轮衬套-右 $\phi 20*\phi 27*13.5$	Bushing, Front Wheel (Right)	PIECE 1
	15	5101-203709-BS0	轴承20*37*9	Bearing 20*37*9	PIECE 2
	16	910004-T501-00000	衬套 $\phi 20.3*\phi 27*71$	Collar $\phi 20.3*\phi 27*71$	PIECE 1
	17	910001-T500-00000	前轮衬套-左	Bushing, Front Wheel (Left)	PIECE 1
	18				
19					

F-6 后网轮 Rear net wheel					
PHOTO	NO.	Part CODE	Chinese/English name and specification		UNIT QTY
	1	350030-T500-00000	后轮外胎	Rear Wheel Outer Tire	PIECE 1
	2	350029-T501-00000	后轮内胎(含气门嘴盖及锁紧螺母)	Inner tube of rear wheel (including valve nozzle cover and locking nut)	PIECE 1
	3	352100-T500-00001	后网轮总成	Spoke Wheel Assy, Rear	PIECE 1
	4	350031-T501-00000	后轮垫带	Rear Wheel Cushion	PIECE 1
	5	351800-T501-00000	后碟刹盘	Brake Disc (Rear)	PIECE 1
	6	5021-06016-DK01	内六花六角法兰面螺栓M6*12	Bolt, Hex. Flange M6*12	PIECE 4
	7	350023-T500-00000	ABS齿圈-前	ABS Gear Ring(Front)	PIECE 1
	8	5014-05008-BS00	内六角沉头螺钉M5*8	Screw, Inner Hex, Countersunk Head	PIECE 3
	9	350038-T500-00000	后轮速传感器支架	Rear wheel speed sensor bracket	PIECE 1
	10	400006-T500-00000	线钩	wire hook	PIECE 1
	11	420008-R100-000	工字胶圈	Ring, Rubber I-Shaped $\phi 9 * \phi 19.5 * 9$	PIECE 1
	12	5001-06016-SC00	六角法兰面螺栓M6*16	Bolt, Hex. Flange	PIECE 2
	13	410003-T501-00000	后轮轴	Axle, Wheel (Rear)	PIECE 1
	14	910002-T500-00000	后轮衬套-左	Bushing, Rear Wheel (Left)	PIECE 1
	15	910003-T500-00000	后轮衬套-右	Bushing, Rear Wheel (Right)	PIECE 1
	16	5018-22520-SC00	平垫 $\phi 22.5 * \phi 35 * 2$	Washer, Flat $\phi 22.5 * \phi 35 * 2$	PIECE 1
	17	5010-22125-SC00	后轮轴螺母	Nut, Wheel Axle (Rear) M22*1.5	PIECE 1
	18	5101-255215-BS0	轴承	Bearing 25*52*15	PIECE 2
	19	910004-T501-00001	衬套 $\phi 25.3 * \phi 32 * 95$	Collar $\phi 25.3 * \phi 32 * 95$	PIECE 1
	20	5103-325207-000	油封 $\phi 32 * \phi 52 * 7$	Oil Seal $\phi 32 * \phi 52 * 7$	PIECE 1

F-7 发动机下护板 Engine lower guard

PHOTO	NO.	Part CODE	Chinese/English name and specification		UNIT	QTY
	1	390097-T501-00000	油冷格栅	Oil Cooling Grille	PIECE	1
	2	5021-06013-DK00	内六花六角法兰面螺栓M6*13	Bolt, Hex. Flange	PIECE	5
	3	5021-05012-DK00	内六花六角法兰面螺栓M5*12	Bolt, Hex. Flange M5*12	PIECE	2
	4	5009-05070-DK00	螺纹夹板M5*1.0*7*14	Clip, Screw Thread M5	PIECE	2
	5	5009-06093-BS00	搭扣6×25×25	Buckle	PIECE	1
	6	390078-T501-00000	工具箱盖	Cover, Tool Box	PIECE	1
	7	5018-06520-BS00	平垫φ6.5*φ20*2	Washer, Flat φ6.5*φ20*2	PIECE	1
	8	5007-06016-HX00	1/4转快锁式螺栓	1/4 Quick-lock Bolt	PIECE	1
	9	5020-05405-BS00	挡圈φ5.4*φ12.5*0.5	Collar φ5.4*φ12.5*0.5	PIECE	1
	10	390029-T501-00000	发动机下护板	Protecting Plate, Engine	PIECE	1
	11	900005-T501-00000	耐磨贴	Wear-resisting Stick	PIECE	6
	12					
	13					
	14					
	15					
	16					
	17					
	18					
	19					
	20					

F-8 前油箱-左-1 Front tank - left-1

PHOTO	NO.	Part CODE	Chinese/English name and specification	UNIT	QTY
	1	5003-08020-SC00	内六角圆柱头螺钉 Screw, Inner Hex. Column Head	PIECE	1
	2	910013-T501-00000	前油箱安装衬套 Front Fuel Tank Mounting Bushing	PIECE	3
	3	420008-T501-00001	工字胶圈 $\phi 29*\phi 19.5*25$ Ring, Rubber I-Shaped $\phi 29*\phi 19.5*25$	PIECE	2
	4	5021-05012-DK00	内六花六角法兰面螺栓M5*12 Bolt, Hex. Flange M5*12	PIECE	2
	5	5009-06093-BS00	搭扣6×25×25 Buckle	PIECE	1
	6	360045-T501-00000	油箱前护板支架 Fuel Tank Front Guard Bracket	PIECE	1
	7	311200-T501-00000	前油箱-左 Front Fuel Tank - Left	PIECE	1
	8	5003-08030-SC00	内六角圆柱头螺钉M8*30 Screw, Inner Hex. Column Head M8*30	PIECE	2
	9	5008-16030-SC00	六角螺母M16*1, 厚3 Bolt, Hex M16*1, THK: 3	PIECE	2
	10	360047-T501-00000	前油箱安装螺母(台阶6) Front oil tank mounting nut	PIECE	1
	11	360047-T501-00001	前油箱安装螺母(台阶11) Front oil tank mounting nut	PIECE	1
	12	420008-T501-00002	工字胶圈 $\phi 29*\phi 19.5*29.5$ Ring, Rubber I-Shaped $\phi 29*\phi 19.5*29.5$	PIECE	1
	13	5021-08010-DK00	内六花六角法兰面螺栓M8*10 Bolt, Hex. Flange	PIECE	1
	14	360046-T501-00000	前油箱支架 Front Fuel Tank Bracket	PIECE	1
	15	5027-08020-BS00	橡胶螺栓M8*20 Elastic Rubber, Bolts M8*20	PIECE	1
	16	5014-05010-BS00	内六角沉头螺钉M5*10 Screw, Inner Hex. Countersunk Head	PIECE	4
	17	310011-T501-00000	油管接头安装板 Fuel Pipe Union Mounting Plate	PIECE	2
	18	5104-012020-000	O型圈 $\phi 12*\phi 2$ O-Ring $\phi 12*\phi 2$	PIECE	2
	19	310006-T501-00001	前油箱盖 Fuel Tank Cover, Front	PIECE	1
	20	420061-T501-00000	油箱盖密封圈 Cover Seal Ring, Fuel Tank	PIECE	1

F-8 前油箱-左-2 Front tank - left-2

PHOTO	NO.	Part CODE	Chinese/English name and specification	UNIT	QTY	
	21	5005-05012-HX00	十字大盘头螺钉M5*12	Screw, Cross-Shaped, Cup Head M5*12	PIECE	2
	22	360036-T501-00000	燃油滤清器支架	Fuel Filter Bracket	PIECE	1
	23	421800-T500-00001	油箱通气管总成	Fuel Tank Vent Pipe Assembly	PIECE	1
	24	310402-T500-00000	油位传感器	Oil Level Sensor	PIECE	1
	25					
	26					
	27					
	28					
	29					
	30					
	31					
	32					
	33					
	34					
	35					
	36					
	37					
	38					
	39					
	40					

F-9 前油箱-右 Front tank - right

PHOTO	NO.	Part CODE	Chinese/English name and specification	UNIT	QTY
	1	5003-08020-SC00	内六角圆柱头螺钉M8*20 Screw, Inner Hex. Column Head	PIECE	1
	2	910013-T501-00000	前油箱安装衬套 Front Fuel Tank Mounting Bushing	PIECE	3
	3	420008-T501-00001	工字胶圈 $\phi 29*\phi 19.5*25$ Ring, Rubber I-Shaped $\phi 29*\phi 19.5*25$	PIECE	2
	4	5021-05012-DK00	内六花六角法兰面螺栓M5*12 Bolt, Hex. Flange M5*12	PIECE	2
	5	5009-06093-BS00	搭扣6×25×25 Buckle	PIECE	1
	6	360045-T501-00000	油箱前护板支架 Fuel Tank Front Guard Bracket	PIECE	1
	7	311300-T501-00000	前油箱-右 Front Fuel Tank-Rght	PIECE	1
	8	5003-08030-SC00	内六角圆柱头螺钉M8*30 Screw, Inner Hex. Column Head M8*30	PIECE	2
	9	5008-16030-SC00	六角螺母M16*1, 厚3 Bolt, Hex M16*1, THK: 3	PIECE	2
	10	360047-T501-00000	前油箱安装螺母(台阶6) Front oil tank mounting nut	PIECE	1
	11	360047-T501-00001	前油箱安装螺母(台阶11) Front oil tank mounting nut	PIECE	1
	12	5027-08020-BS00	橡胶螺栓M8*20 Elastic Rubber, Bolts M8*20	PIECE	1
	13	360046-T501-00000	前油箱支架 Front Fuel Tank Bracket	PIECE	1
	14	5021-08010-DK00	内六花六角法兰面螺栓M8*10 Bolt, Hex. Flange	PIECE	1
	15	420008-T501-00002	工字胶圈 $\phi 29*\phi 19.5*29.5$ Ring, Rubber I-Shaped $\phi 29*\phi 19.5*29.5$	PIECE	1
	16	5014-05010-BS00	内六角沉头螺钉M5*10 Screw, Inner Hex. Countersunk Head	PIECE	2
	17	310011-T501-00000	油管接头安装板 Fuel Pipe Union Mounting Plate	PIECE	1
	18	5104-012020-000	O型圈 $\phi 12*\phi 2$ O-Ring $\phi 12*\phi 2$	PIECE	1
	19	900005-T501-00000	耐磨贴 Wear-resisting Stick	PIECE	1
	20	420061-T501-00000	油箱盖密封圈 Cover Seal Ring, Fuel Tank	PIECE	1

F-9 前油箱-右-1 Front tank - right

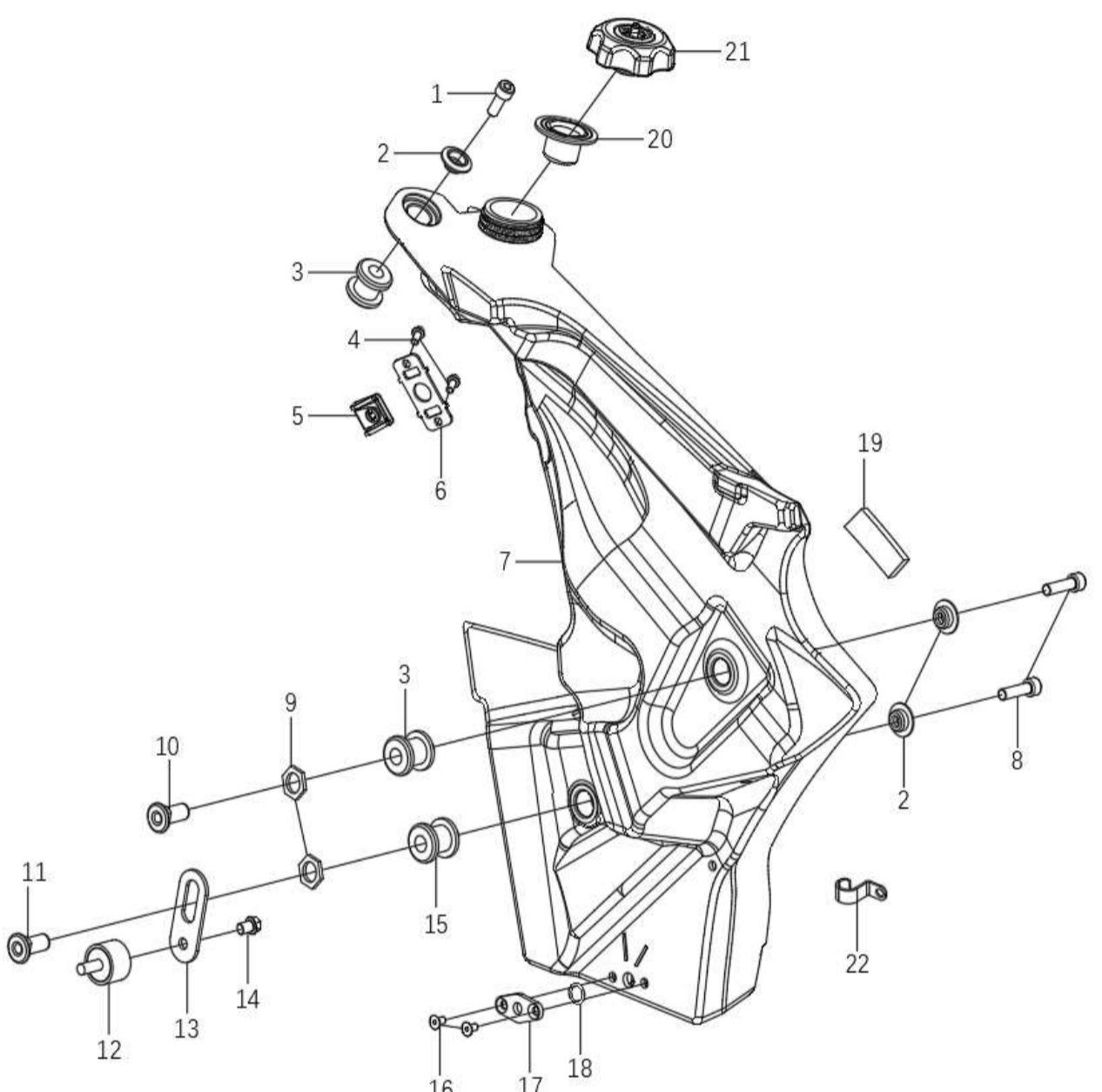
PHOTO	NO.	Part CODE	Chinese/English name and specification	UNIT	QTY	
	21	310006-T501-00001	前油箱盖 Fuel Tank Cover, Front	PIECE	1	
	22	400006-R100-000	线钩 wire hook	PIECE	1	
	23					
	24					
	25					
	26					
	27					
	28					
	29					
	30					
	31					
	32					
	33					
	34					
	35					
	36					
	37					
	38					
	39					
	40					

F-10 后油箱-1 Rear oil tank-1						
PHOTO	NO.	Part CODE	Chinese/English name and specification		UNIT	QTY
	1	5007-08011-BS00	后油箱安装螺栓M8*11, 台阶高25	Rear tank mounting bolts M8*11, step height 25	PIECE	4
	2	420049-T501-00000	后油箱支撑胶	Rear Fuel Tank Support Rubber	PIECE	4
	3	310007-T501-00001	后油箱盖	Cover, Rear Fuel Tank	PIECE	1
	4	420061-T501-00000	油箱盖密封圈	Cover Seal Ring, Fuel Tank	PIECE	1
	5	311400-T501-00000	后油箱	Rear Fuel Tank	PIECE	1
	6	310008-T501-00000	后油箱通气管接头	Rear Fuel Tank Vent Pipe Connector	PIECE	1
	7	5104-005020-000	O型圈 $\phi 5 * \phi 2$	O-Ring $\phi 5 * \phi 2$	PIECE	1
	8	420048-T501-00000	侧支架挂钩	Side Stand Hook	PIECE	1
	9	360048-T501-00000	侧支架挂钩支架	Side Stand Hook Bracket	PIECE	1
	10	5021-05012-DK00	内六角六角法兰面螺栓M5*12	Bolt, Hex. Flange M5*12	PIECE	2
	11	5004-06012-BS01	内六角台阶螺钉M6*12, 台阶8.5*3.5	Stepping Screw, Inner Hex. M6*12, Stepping	PIECE	2
	12	390083-T501-00000	后轮挡水皮	Rear wheel water barrier leather	PIECE	1
	13	390082-T501-00000	后油箱保护罩	Rear Fuel Tank Protection Cover	PIECE	1
	14	5014-06012-BS00	内六角沉头螺钉M6*12	Screw, Inner Hex. Countersunk Head	PIECE	5
	15	360041-T501-00000	消声器安装支架	Muffler mounting bracket	PIECE	1
	16	910011-R100-000	衬管 $\phi 8 * \phi 12.5 * 29$	Sleeve $\phi 8 * \phi 12.5 * 29$	PIECE	1
	17	371001-R201-000	后脚踏安装工字胶 $\phi 12 * \phi 23.5 * 30$	I-Shaped Installation Rubber, Rear Foot Pedal	PIECE	1
	18	5021-06013-DK00	内六角六角法兰面螺栓M6*13	Bolt, Hex. Flange	PIECE	8
	19	5014-05010-BS00	内六角沉头螺钉M5*10	Screw, Inner Hex. Countersunk Head	PIECE	2
	20	5104-012020-000	O型圈 $\phi 12 * \phi 2$	O-Ring $\phi 12 * \phi 2$	PIECE	1

F-10 后油箱-2 Rear oil tank-2

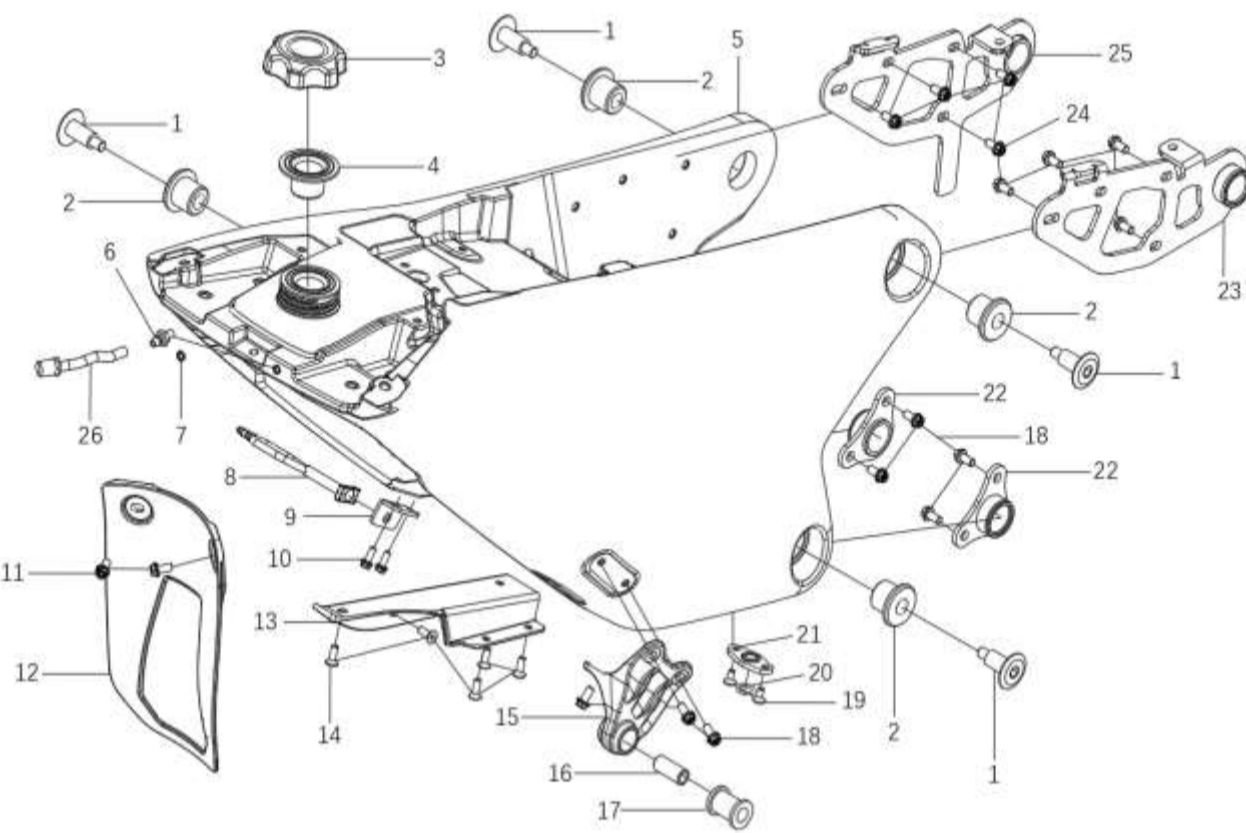
PHOTO	NO.	Part CODE	Chinese/English name and specification	UNIT	QTY	
	21	310011-T501-00000	油管接头安装板 Fuel Pipe Union Mounting Plate	PIECE	1	
	22	360049-T501-00000	后油箱下支架 Lower Bracket, Rear Fuel Tank	PIECE	2	
	23	360051-T501-00000	后油箱加强支架-右 Reinforcement Support Right, Rear Fuel Tank	PIECE	1	
	24	5021-06013-DK00	内六花六角法兰面螺栓 Bolt, Hex. Flange	PIECE	8	
	25	360050-T501-00000	后油箱加强支架-左 Reinforcement Support Left, Rear Fuel Tank	PIECE	1	
	26	311700-T501-00000	单向透气阀 One-way Went Valve	PIECE	1	
	27					
	28					
	29					
	30					
	31					
	32					
	33					
	34					
	35					
	36					
	37					
	38					
	39					
	40					

F-11 电器元件-1 Electrical components-1

PHOTO	NO.	Part CODE	Chinese/English name and specification	UNIT	QTY
	1	420900-T501-00001	电瓶绑带 Battery straps	PIECE	1
	2	331400-T501-00001	电瓶 Battery	PIECE	1
	3	332600-T501-00000	点火线圈 Ignition Coil	PIECE	1
	4	380600-T501-00000	座垫锁拉索 Seat Lock Cable	PIECE	1
	5	5004-06020-BS01	内六角花型盘头螺钉M6*20 Screw, Inner Hex. Flat Head M6*20	PIECE	4
	6	420008-R100-000	工字胶圈 $\phi 9 * \phi 19.5 * 9$ Ring, Rubber I-Shaped $\phi 9 * \phi 19.5 * 9$	PIECE	4
	7	330100-R100-00001	启动继电器 Starting Relay	PIECE	1
	8	5006-04013-HX00	自攻钉M4. 2X13 Tapping Screw M4. 2X13	PIECE	2
	9	331300-R100-00001	USB充电器 USB Charger	PIECE	1
	10	330600-T501-00001	喇叭 Horn	PIECE	1
	11	5021-06012-DK00	内六花六角法兰面螺栓M6*12 Bolt, Hex. Flange M6*12	PIECE	1
	12	331600-T500-00000	继电器 Relay	PIECE	1
	13	350004-R100-000	双线卡 Clip, dual wires	PIECE	7
	14	5021-06012-DK00	内六花六角法兰面螺栓M6*12 Bolt, Hex. Flange M6*12	PIECE	1
	15	351500-T500-00000	前轮速传感器(前轮用) Front wheel speed sensor	PIECE	1
	16	360900-T501-00000	电器安装支架总成 Electrical components Mounting Bracket	PIECE	1
	17	5009-05070-DK00	螺纹夹板M5*1.0*7*14 Clip, Screw Thread M5	PIECE	2
	18	332000-R201-000	侧倾传感器 Sensor, Toppling	PIECE	1
	19	5018-05008-SC00	平垫 $\phi 5$ Washer, Flat $\phi 5$	PIECE	2
	20	5005-05025-SC00	十字盘头螺钉M5*25 Screw, Cross-Shaped, Cup Head	PIECE	2

F-11 电器元件-2 Electrical components-2

PHOTO	NO.	Part CODE	Chinese/English name and specification	UNIT	QTY	
	21	5004-06016-BS00	内六角大盘头螺钉M6*16 Screw, Inner Hex. Flat Head	PIECE	1	
	22	370500-R100-000	侧支架熄火开关 Engine Cutoff Switch, Side Stand	PIECE	1	
	23	5021-06025-DK00	内六花六角法兰面螺栓M6*25 Bolt, Hex. Flange	PIECE	2	
	24	5009-06080-DK00	螺纹夹板M6*1.0*8*16 Clip, Screw Thread M6	PIECE	2	
	25	330200-T501-00000	调压整流器 Rectifier & Regulator Assv	PIECE	1	
	26	310200-T501-00000	ECU ECU	PIECE	1	
	27	5005-05012-HX00	十字大盘头螺钉M5*12 Screw, Cross-Shaped, Cup Head M5*12	PIECE	2	
	28	5003-08020-SC00	内六角圆柱头螺钉M8*20 Screw, Inner Hex. Flat Head	PIECE	2	
	29	331800-T500-00000	全车套锁总成 Lock Assy	PIECE	1	
	30	5014-06020-BS00	内六角沉头螺钉M6*20 Screw, Inner Hex. Countersunk Head	PIECE	2	
	31	5021-06016-DK01	内六花六角法兰面螺栓M6*16 Bolt, Hex. Flange	PIECE	1	
	32	330700-R102-000	闪光器 Flasher	PIECE	1	
	33	351300-T500-00000	ABS总成 ABS Assy	PIECE	1	
	34	351500-R110-00000	前轮速传感器(后轮用) Front wheel speed sensor	PIECE	1	
	35	350700-T500-00000	后制动开关 Rear brake switch	PIECE	2	
	36	331600-R110-00000	继电器 Relay	PIECE	1	
	37					
	38					
	39					
	40					

F-12 电器元件-3 Electrical components-3

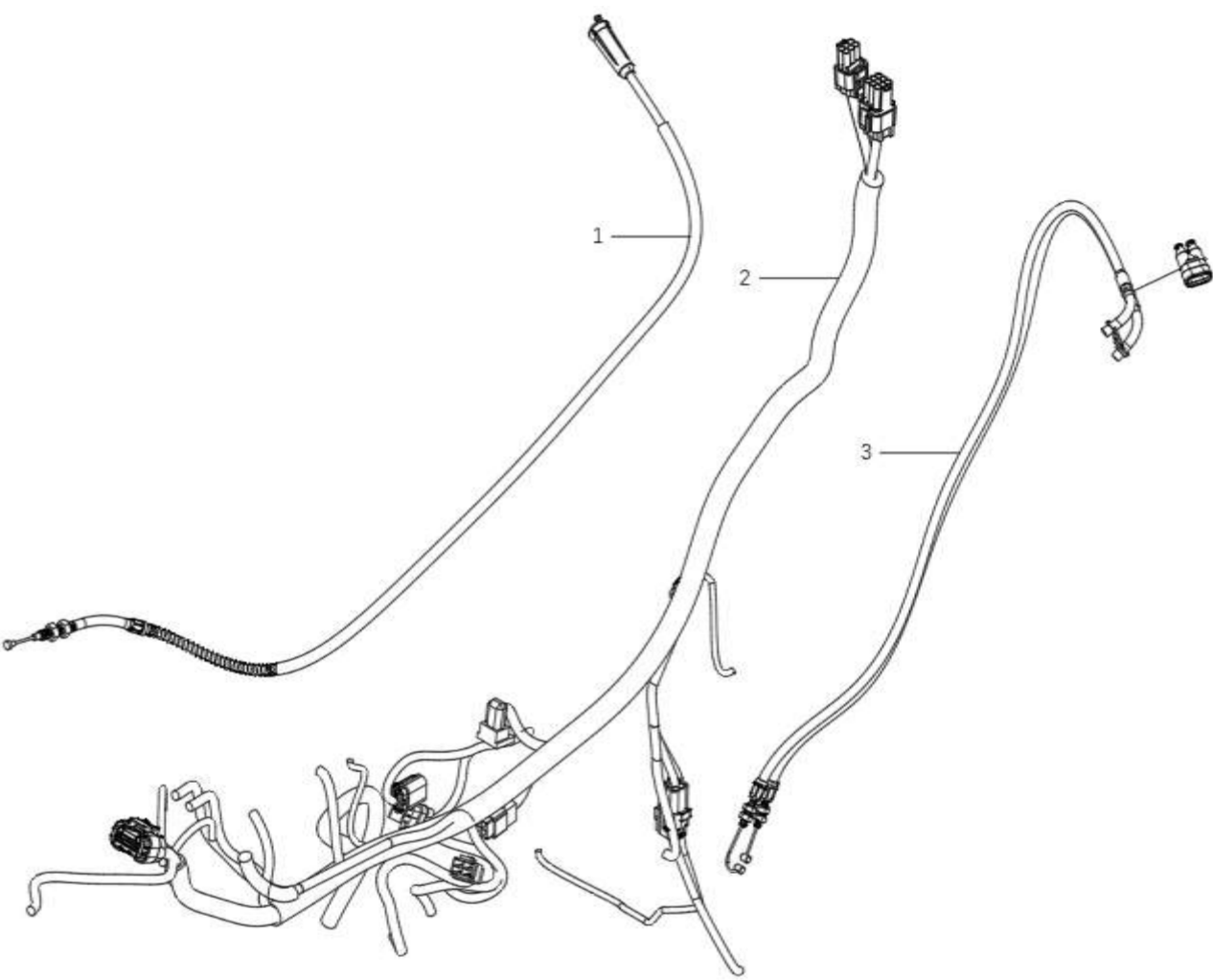
PHOTO	NO.	Part CODE	Chinese/English name and specification		UNIT	QTY
	1	380500-T501-00001	离合拉索	Clutch Cable	PIECE	1
	2	331700-T500-00002	主电缆(配TFT仪表, 不带大灯开关)	Main cable (with TFT meter, without headlight switch)	PIECE	1
	3	311900-T500-00000	油门拉索总成	Throttle Cable Assembly	PIECE	1
	4					
	5					
	6					
	7					
	8					
	9					
	10					
	11					
	12					
	13					
	14					
	15					
	16					
	17					
	18					
	19					
	20					

F-13 碳罐 Carbon canister

PHOTO	NO.	Part CODE	Chinese/English name and specification	UNIT	QTY
	1	420300-T500-00000	碳罐连接管2(直管4*8*617) Connecting pipe 2, Carbon Canister (straight pipe 4*8*617)	PIECE	1
	2	320400-R100-000	碳罐 Carbon Canister	PIECE	1
	3	420400-T500-00002	碳罐连接管3 Connecting pipe 3, Carbon Canister	PIECE	1
	4	330500-R100-000	倾倒阀 Toppling Valve	PIECE	1
	5				
	6				
	7				
	8				
	9				
	10				
	11				
	12				
	13				
	14				
	15				
	16				
	17				
	18				
	19				
	20				

F-14 前挡泥板 Front fender

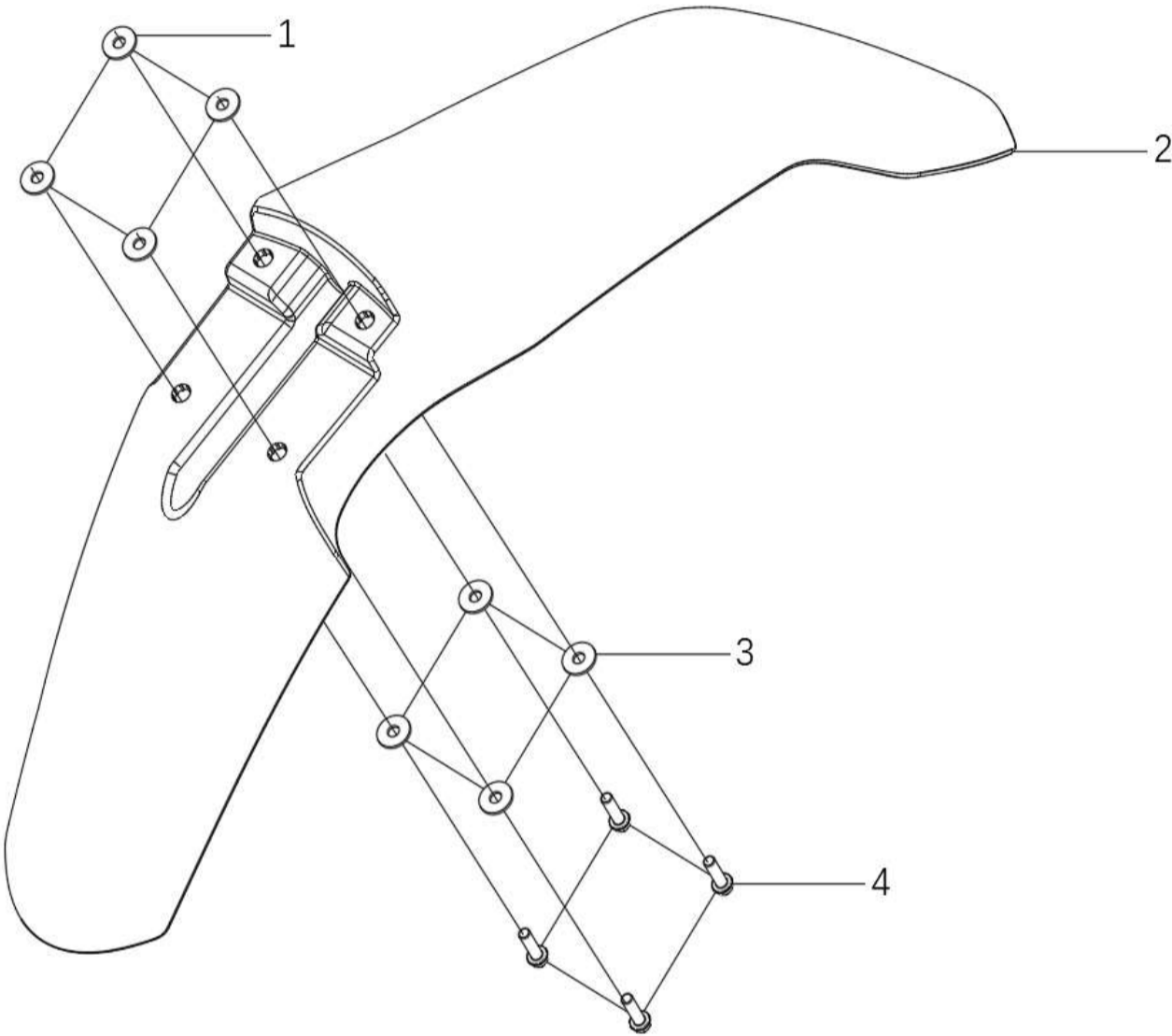
PHOTO	NO.	Part CODE	Chinese/English name and specification	UNIT	QTY	
	1	5013-06006-BS00	翻边衬套 $\phi 6 * \phi 9 * \phi 6$	Bushing, Flange $\Phi 6x\Phi 9x6$	PIECE	4
	2	390015-T501-00000	前挡泥板	Front Fender	PIECE	1
	3	5018-06015-SC00	平垫 $\phi 6.3 * \phi 18 * 1.5$	Washer, Flat	PIECE	4
	4	5021-06020-DK00	内六花六角法兰面螺栓M6*20	Bolt, Hex. Flange	PIECE	4
	5					
	6					
	7					
	8					
	9					
	10					
	11					
	12					
	13					
	14					
	15					
	16					
	17					
	18					
	19					
	20					

F-15 节气门

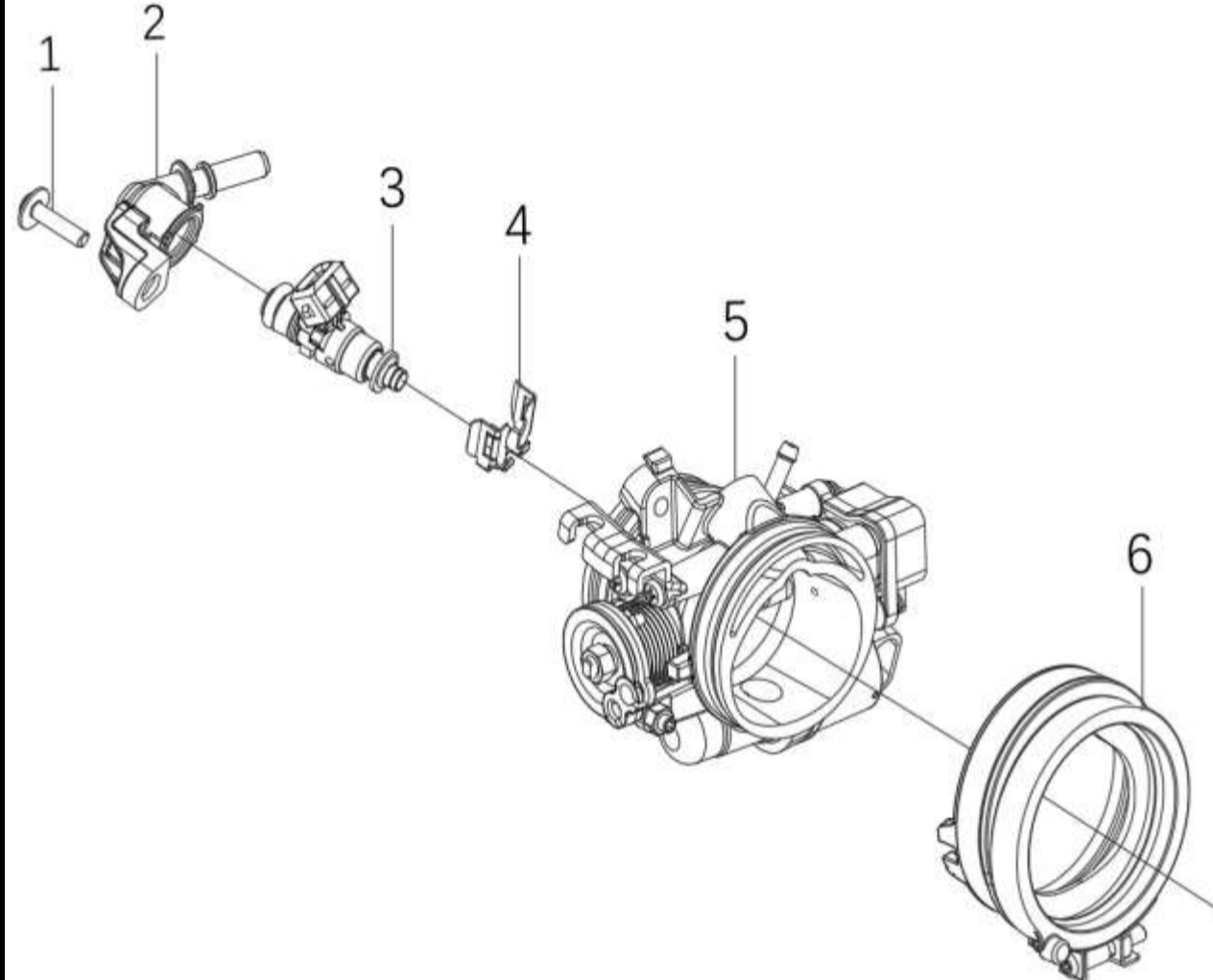
PHOTO	NO.	Part CODE	Chinese/English name and specification		UNIT	QTY
	1	5021-06020-DK00	内六花六角法兰面螺栓M6*20	Bolt, Hex. Flange	PIECE	1
	2	310012-T501-00000	喷油器帽	Fuel Injector Cap	PIECE	1
	3	310101-T501-00000	喷油器	Fuel Injector	PIECE	1
	4	310005-P200-00000	喷油器卡夹	Fuel Injector Clamp	PIECE	1
	5	310100-T501-00000	节气门总成	Throttle Body Assy	PIECE	1
	6	320500-T501-00000	进气管总成	Intake Pipe Assy	PIECE	1
	7					
	8					
	9					
	10					
	11					
	12					
	13					
	14					
	15					
	16					
	17					
	18					
	19					
	20					

F-16 燃油蒸发系统-1 Fuel evaporation system

PHOTO	NO.	Part CODE	Chinese/English name and specification	UNIT	QTY
	1	350100-R100-000	快速接头 Quick Coupling	PIECE	2
	2	5011-01570-BS00	单耳无极卡箍 Clip	PIECE	2
	3	420054-T501-00000	燃油管6 Fuel Pipe 6	PIECE	1
	4	5011-01400-BS00	单耳无极卡箍 Clip	PIECE	2
	5	310500-R100-000	燃油滤清器 Fuel Filter	PIECE	1
	6	420046-P200-00000	燃油滤清器胶套 Fuel Filter Sleeve	PIECE	1
	7	420053-T501-00000	燃油管5 Fuel Pipe 5	PIECE	1
	8	310400-T501-00000	燃油泵 Fuel Pump	PIECE	1
	9	5005-05020-SC00	十字盘头螺钉M5*20 Screw, Inner Hex. Flat Head M5*20	PIECE	4
	10				
	11				
	12				
	13				
	14				
	15				
	16				
	17				
	18				
	19				
	20				

F-17 燃油蒸发系统-1 Fuel evaporation system-1

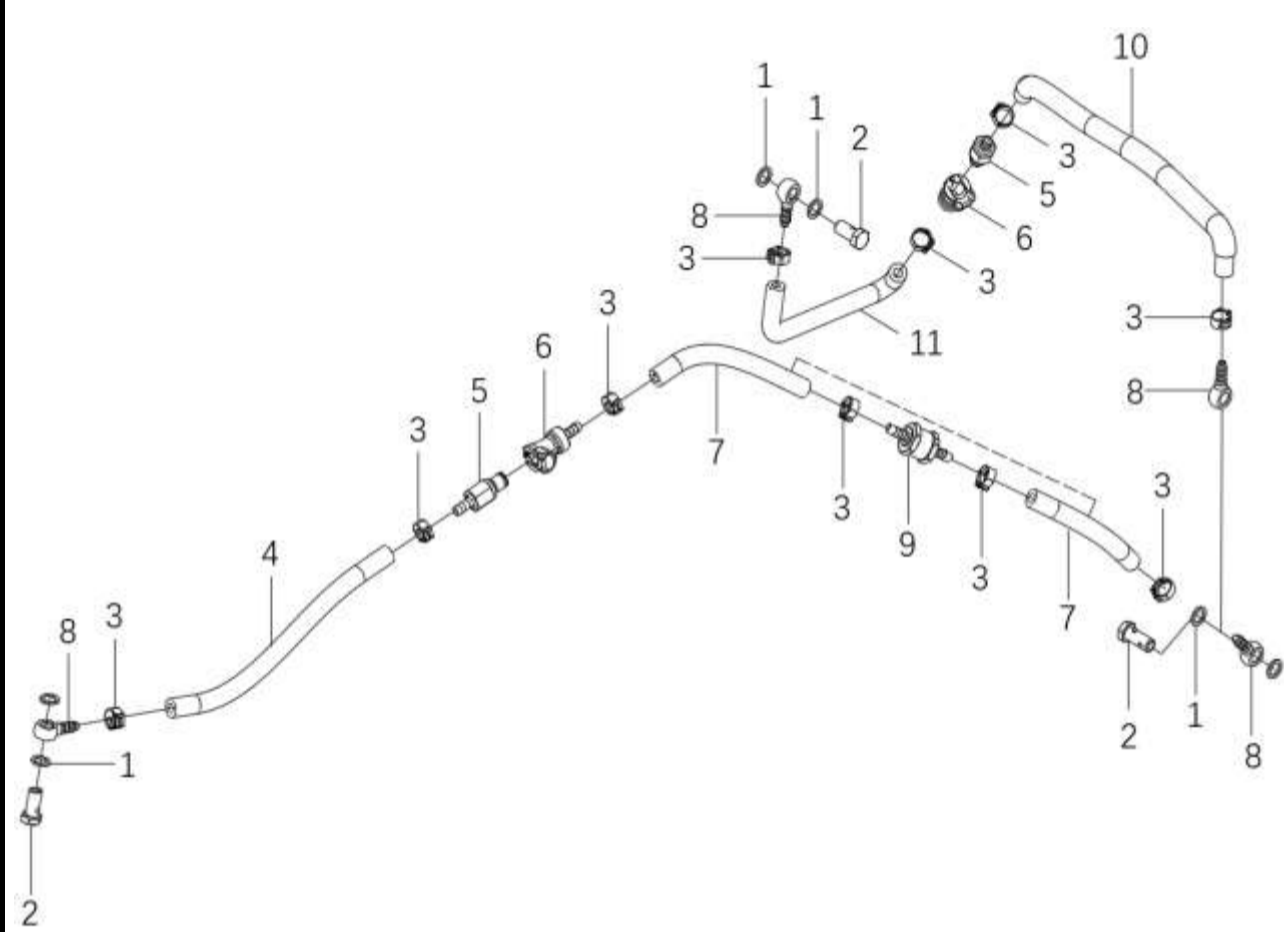
PHOTO	NO.	Part CODE	Chinese/English name and specification	UNIT	QTY
	1	350002-R100-000	铜垫圈 $\phi 10 * \phi 15 * 1.5$ Copper Washer $\phi 10 * \phi 15 * 1.5$	PIECE	6
	2	350001-T501-00003	过油螺栓M10*1*20 Oil Bolt M10*1.0*20	PIECE	3
	3	5011-01330-BS00	单耳无极卡箍 Clip	PIECE	10
	4	420001-T501-00000	燃油管1 Fuel Pipe 1	PIECE	1
	5	311000-T501-00000	快速插头公头 Quick Plug Male Head	PIECE	2
	6	311100-T501-00000	快速插头母头 Quick Plug Female Head	PIECE	2
	7	420002-T501-00000	燃油管2 Fuel Pipe 2	PIECE	2
	8	310010-T501-00000	球形油管接头 Spherical Tubing Joint	PIECE	4
	9	311800-T501-00000	单向阀 One-way Valve	PIECE	1
	10	420051-T501-00000	燃油管3 Fuel Pipe 3	PIECE	1
	11	420052-T501-00000	燃油管4 Fuel Pipe 4	PIECE	1
	12				
	13				
	14				
	15				
	16				
	17				
	18				
	19				
	20				

F-18 大灯支架 Headlight bracket						
PHOTO	NO.	Part CODE	Chinese/English name and specification	UNIT	QTY	
	1	5003-05012-SC00	内六角圆柱头螺钉 Screw, Inner Hex. Column Head	PIECE	4	
	2	360022-R201-000	大灯支架压板 Press-plate, Headlight Bracket	PIECE	2	
	3	360014-T501-00000	大灯支架 Bracket, Headlight	PIECE	1	
	4	420036-R201-000	大灯支架胶套 Rubber, Headlight Bracket $\phi 8 * \phi 11 / \phi 13 * 12.8$	PIECE	2	
	5	5007-06021-HX00	1/4转快锁式螺栓 1/4Turn fast locking bolt	PIECE	4	
	6	5012-07024-FH00	弹出弹簧 $\phi 7.63 * \phi 11.43 * 24.13$ Pop-up spring $\phi 7.63 * \phi 11.43 * 24.13$	PIECE	4	
	7	5018-07035-BS00	杯形垫圈 $\phi 7 * \phi 24 * 3.5$ cup washer $\phi 7 * \phi 24 * 3.5$	PIECE	4	
	8	5018-07035-BS00	挡圈 $\phi 5.4 * \phi 12.5 * 0.5$ cup washer $\phi 7 * \phi 24 * 3.5$	PIECE	4	
	9	5009-06093-BS00	搭扣M6*9.3, 宽25长25 Buckle	PIECE	4	
	10	5021-06013-DK00	内六角六角法兰面螺栓M6*13 Bolt, Hex. Flange	PIECE	3	
	11	5027-06012-BS00	橡胶螺栓M6*12 Rubber Bolt M6*12	PIECE	3	
	12	5007-06040-BS00	大灯调节螺钉M6*40 Headlight adjustment screw	PIECE	2	
	13	5009-06080-DK00	螺纹夹板M6*1.0*8*16 Clip, Screw Thread M6	PIECE	2	
	14	5012-01036-SC00	大灯调节弹簧 $\phi 1.4 * \phi 8.6 * 36$ Adjusting Spring, Headlight	PIECE	2	
	15	5015-03020-SC00	开口销R3*20 Pin, Split $\phi 0.9$	PIECE	2	
	16	360044-T501-00000	大灯安装支架 Headlight Mounting Bracket	PIECE	1	
	17					
	18					
	19					
	20					

F-19 发动机 Engine

PHOTO	NO.	Part CODE	Chinese/English name and specification	UNIT	QTY	
	1	5001-10030-SC00	六角法兰面螺栓M10*1.25*30 Bolt, Hex. Flange M10*1.25*130	PIECE	2	
	2	AEDT01-B09	发动机总成 Engine Assy. (NC450S, Oil cooling pipe)	PIECE	1	
	3	5021-06012-DK00	内六花六角法兰面螺栓M6*12 Bolt, Hex. Flange M6*12	PIECE	1	
	4	360088-T501-00000	高压包压板 Pressing Pate, Coil to Spark Plug	PIECE	1	
	5	421700-T501-00000	废气管总成 Exhaust Pipe Assembly	PIECE	1	
	6	390023-T501-00000	发动机小链轮盖 Cover, Engine Sprocket	PIECE	1	
	7	5001-06030-SC01	六角法兰面螺栓M6*30 Bolt, Hex. Flange	PIECE	2	
	8	352300-T500-00000	链条 Chain	PIECE	1	
	9	5021-06020-DK00	内六花六角法兰面螺栓M6*20 Bolt, Hex. Flange	PIECE	1	
	10	370200-T501-00000	变档踏板总成 Pedal, Gear Shift Assy	PIECE	1	
	11	5008-10115-SC00	六角法兰面自锁螺母 Tapping Nut, Hex. Flange M10*1.25	PIECE	3	
	12	5001-10145-DK00	六角法兰面螺栓M10*145 Bolt, Hex. Flange M10x1.25*145	PIECE	2	
	13	5001-10130-DK01	六角法兰面螺栓M10*130 Bolt, Hex. Flange M10*1.25*130	PIECE	1	
	14	400006-T501-00000	线钩 wire hook	PIECE	1	
	15					
	16					
	17					
	18					
	19					
	20					

F-20 方向把、后视镜-1 Steering handle, rearview mirror-1

PHOTO	NO.	Part CODE	Chinese/English name and specification		UNIT	QTY
	1	400100-T500-00000	后视镜总成-左	Rear View Mirror(Left)	PIECE	1
	2	330800-T500-00001	仪表总成	Speedometer Assy	PIECE	1
	3	400200-T500-00000	后视镜总成-右	Rear View Mirror(Right)	PIECE	1
	4	380100-T500-00001	手把胶-左	Grip(Left),Handle Bar	PIECE	1
	5	5021-08045-SC00	内六花六角法兰面螺栓M8*45	Bolt,Hex.Flange	PIECE	4
	6	420033-T501-00002	方向把缓冲胶套(EPDM,黑色)	Handle Bar Rubber Cover	PIECE	4
	7	420033-T501-00003	方向把缓冲胶套(TPU,黄色)	Handle Bar Rubber Cover	PIECE	4
	8	370024-T501-00001	方向把下卡座缓冲块	Buffer Holder, Handle Bar Lower	PIECE	4
	9	370002-T501-00001	方向把上卡子	Clip, Handle Bar Upper	PIECE	2
	10	380200-T500-00001	手把胶总成-右	Grip(Right),Handle Bar	PIECE	1
	11	330900-T500-00000	离合手柄总成	Lever,Clutch Assy	PIECE	1
	12	330901-T500-00000	离合手柄卡座	Holder,Lever Clutch	PIECE	1
	13	5021-06020-DK00	内六花六角法兰面螺栓M6*20	Bolt,Hex.Flange	PIECE	4
	14	331000-T500-00002	手把开关-左(配TFT仪表,不带背光)	Handlebar switch - left (with TFT meter, no	PIECE	1
	15	370001-T501-00001	方向把下卡座	Clip, Handle Bar Lower	PIECE	2
	16	370026-T501-00001	方向把下活动卡子	Movable Clips, Handle Bar Lower	PIECE	2
	17	370016-T501-00001	方向把下活动卡子固定块	Movable Clips Fixed Block, Handle Bar Lower	PIECE	2
	18	5003-10035-DK00	内六花圆柱头螺钉M10*35	Screw, Inner Hex.Column Head	PIECE	4
	19	370023-T501-00000	方向把下卡子增高块	Clip Heightening block, Handle Bar Lower	PIECE	4
	20	380900-T500-00000	加油器	Fueler	PIECE	1

F-20 方向把、后视镜-2 Steering handle, rearview mirror-2

PHOTO	NO.	Part CODE	Chinese/English name and specification	UNIT	QTY	
	21	331100-T500-00002	手把开关-右(不带大灯开关) Handle switch - right (without headlight)	PIECE	1	
	22	380300-T500-00001	方向把(配小体积右开关) Direction handle (with small volume right)	PIECE	1	
	23	350202-T500-00000	制动手柄卡座 Brake handle Holder	PIECE	1	
	24	350200-T501-00000	前制动泵 Bumper Assy, Front Brake	PIECE	1	
	25					
	26					
	27					
	28					
	29					
	30					
	31					
	32					
	33					
	34					
	35					
	36					
	37					
	38					
	39					
	40					

F-21 后挡泥板后段 Rear section of rear fender

PHOTO	NO.	Part CODE	Chinese/English name and specification	UNIT	QTY	
	1	5007-08015-BS00	尾包安装螺栓M8*15, 台阶5.5	Tail pack mounting bolt	PIECE 2	
	2	5004-05016-BS01	内六角盘头螺钉M5*16	Screw, Inner Hex. Flat Head M5*16	PIECE 2	
	3	390004-T500-00000	后尾盖	Cap, Rear Tail	PIECE 1	
	4	5001-08025-SC00	六角法兰面螺栓M8*25	Bolt, Hex. Flange	PIECE 4	
	5	390020-T500-00000	后挡泥后段	Rear Part, Rear Fender	PIECE 1	
	6	341100-T500-00001	后转向灯-右	Rear Turning Light (Right)	PIECE 1	
	7	5009-04040-SC00	自攻夹ST4.8*1.6*4*12.5	Clip, Tapping Screw	PIECE 3	
	8	390002-T500-00000	后挡泥内衬板	Inner Liner, Rear Fender	PIECE 1	
	9	5006-04015-HX00	自攻钉ST4.8*15	Tapping Screw	PIECE 4	
	10	340700-R102-000	后反射器	Rear Reflector	PIECE 1	
	11	420009-R100-000	后牌照缓冲胶 $\phi 8 * \phi 10 * 11$	Rear Licence Cushion	PIECE 1	
	12	5008-05050-SC00	六角法兰面螺母M5	Bolt, Hex. Flange M6	PIECE 2	
	13	340300-T501-00001	牌照灯总成	License Light Assy	PIECE 1	
	14	5005-05012-HX00	十字大盘头螺钉M5*12	Screw, Cross-Shaped, Cup Head M5*12	PIECE 2	
	15	340200-T501-00001	尾灯总成	Tail light assembly	PIECE 1	
	16	341000-T500-00001	后转向灯-左	Rear Turning Light (Left)	PIECE 1	
	17	5005-05012-HX00	十字大盘头螺钉M5*12	Screw, Cross-Shaped, Cup Head M5*12	PIECE 3	
	18					
	19					
	20					

F-22 座垫 Cushion

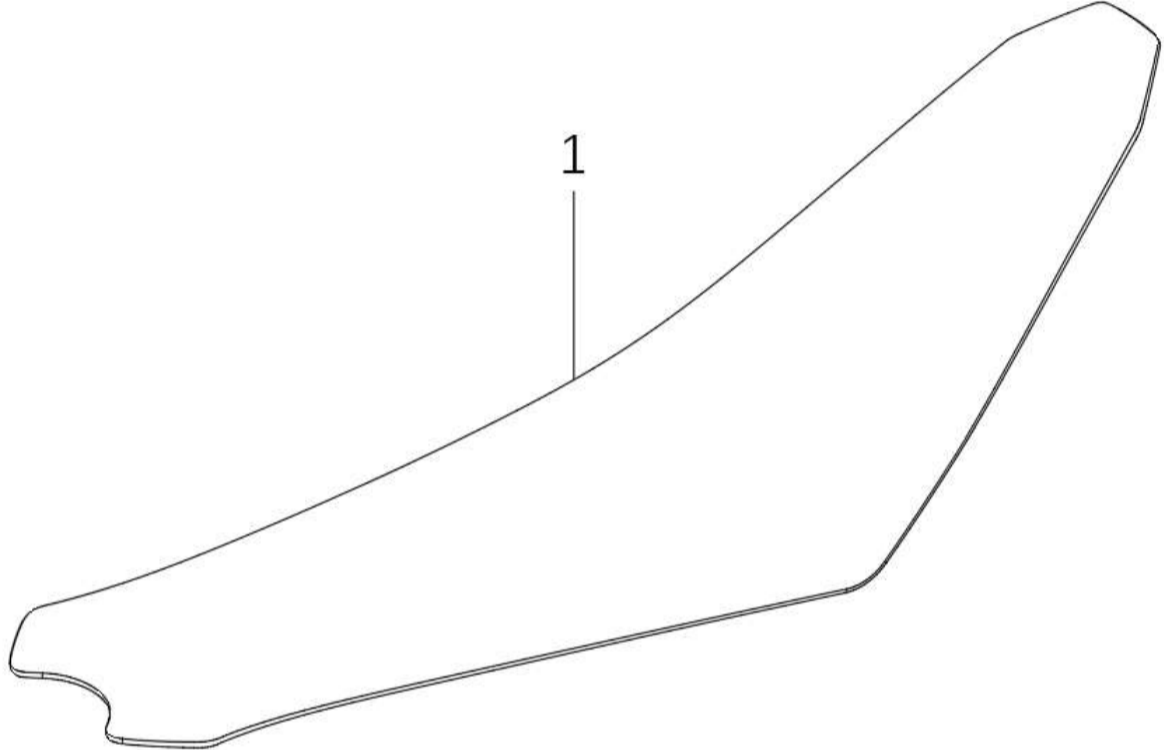
PHOTO	NO.	Part CODE	Chinese/English name and specification	UNIT	QTY	
	1	360700-T500-00000	座垫总成	Cushion	PIECE	1
	2					
	3					
	4					
	5					
	6					
	7					
	8					
	9					
	10					
	11					
	12					
	13					
	14					
	15					
	16					
	17					
	18					
	19					
	20					

F-23 缓冲体 Buffer

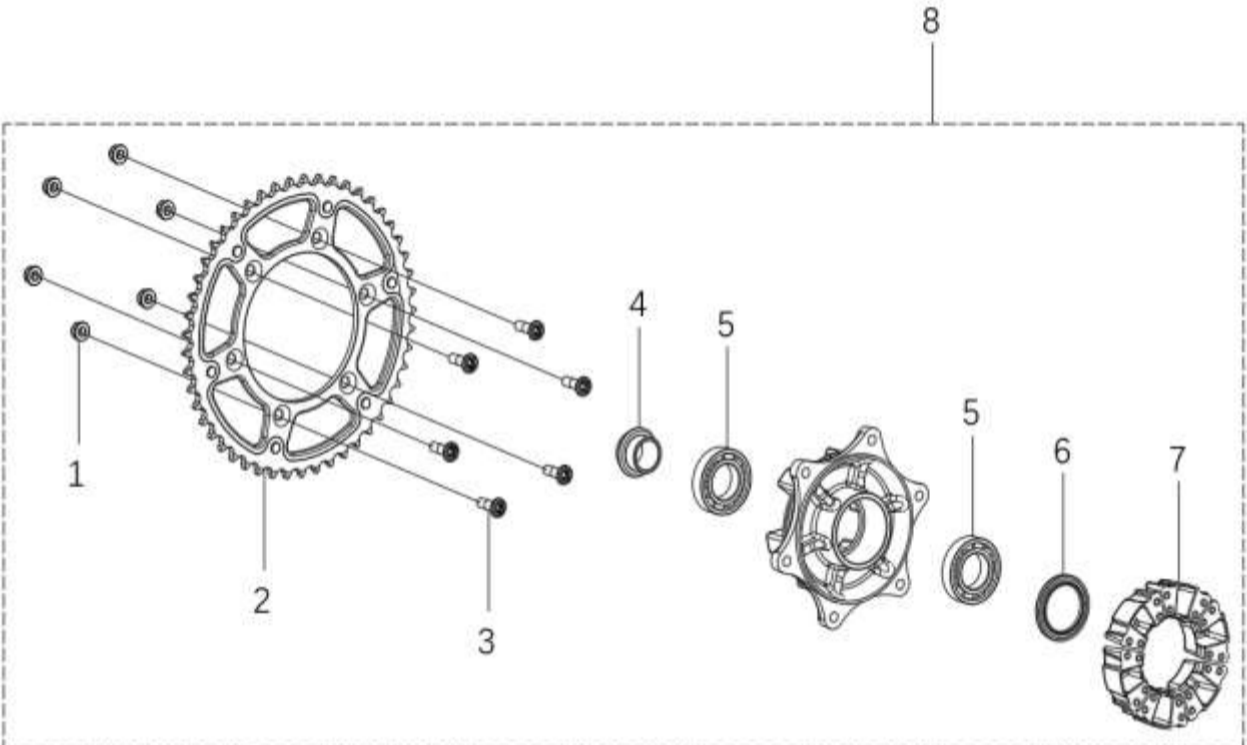
PHOTO	NO.	Part CODE	Chinese/English name and specification		UNIT	QTY
	1	5008-08085-SC00	六角法兰面自锁螺母M8	Tapping Nut, Hex. Flange M8*1.25	PIECE	6
	2	351902-T501-00000	大链轮	Large sprocket	PIECE	1
	3	5023-08027-DK00	内六花沉头螺钉M8x27	Internal six-flower countersunk head screws	PIECE	6
	4	351901-T500-00000	T型衬套	T-shape bushing	PIECE	1
	5	5101-305513-BS0	轴承30*55*13	bearing 30*55*13	PIECE	2
	6	5103-405504-000	油封 $\phi 40.9 * \phi 55 * 4$	oil seal $\phi 40.9 * \phi 55 * 4$	PIECE	1
	7	350022-T501-00000	后链轮缓冲胶	Rear Chain Wheel Buffer	PIECE	6
	8	351900-T500-00000	缓冲体总成	Buffer assembly	PIECE	1
	9					
	10					
	11					
	12					
	13					
	14					
	15					
	16					
	17					
	18					
	19					
	20					

F-24 空滤器 Air filter

PHOTO	NO.	Part CODE	Chinese/English name and specification		UNIT	QTY
	1	5021-06012-DK00	内六花六角法兰面螺栓M6*12,	Bolt, Hex. Flange	PIECE	4
	2	320300-T501-00001	空滤器总成	Air filter assembly	PIECE	1
	3	5018-06526-SC00	平垫 $\phi 6.5 * \phi 16 * 2.6$	Washer, Flat	PIECE	3
	4					
	5					
	6					
	7					
	8					
	9					
	10					
	11					
	12					
	13					
	14					
	15					
	16					
	17					
	18					
	19					
	20					

F-25 前大灯 Headlights						
PHOTO	NO.	Part CODE	Chinese/English name and specification		UNIT	QTY
	1	341700-T501-00000	前大灯总成-右	Headlight assembly-right	PIECE	1
	2	5021-05012-DK00	内六角六角法兰面螺栓M5*12	Bolt, Hex. Flange M5*12	PIECE	4
	3	341600-T501-00000	前大灯总成-左	Headlight assembly-left	PIECE	1
	4	341701-T501-00000	前大灯胶套-右	Front headlight rubber cover-right	PIECE	1
	5	341601-T501-00000	前大灯胶套-左	Front headlight rubber cover-left	PIECE	1
	6	390081-T501-00000	大灯装饰件	Headlight decoration piece	PIECE	1
	7	5004-06012-BS01	内六角盘头螺钉M6*12	Screw, Inner Hex. Flat Head	PIECE	4
	8	330008-T501-00001	大灯控制模块	Headlight control module	PIECE	1
	9					
	10					
	11					
	12					
	13					
	14					
	15					
	16					
	17					
	18					
	19					
	20					

F-26 制动踏板 Brake pedal assembly					
PHOTO	NO.	Part CODE	Chinese/English name and specification		UNIT QTY
	1	5018-08210-SC00	平垫 $\phi 8.2 * \phi 26 * 1$	Flat pad $\phi 8.2 * \phi 26 * 1$	PIECE 1
	2	5103-122002-000	油封 $\phi 12.6 * \phi 20.4 * 2.5$	Oil Seal $\phi 12.6 * \phi 20.4 * 2.5$	PIECE 2
	3	5007-08016-SC00	制动臂螺栓M8(台阶高度 $\phi 12 * 18.2$)	Brake arm bolt	PIECE 1
	4	5012-01048-LB00	后制动回位簧 $\phi 1.6 * \phi 8 * 48$	Rear brake return spring $\phi 1.6 * \phi 8 * 48$	PIECE 1
	5	370010-T501-00000	刹车摇臂	Brake rocker arm	PIECE 1
	6	5021-05012-DK00	内六花六角法兰面螺栓M5*12	Bolt, Hex. Flange M5*12	PIECE 2
	7	350009-T500-00000	后制动踏板	Rear brake pedal	PIECE 1
	8				
	9				
	10				
	11				
	12				
	13				
	14				
	15				
	16				
	17				
	18				
	19				
	20				

F-27 前减震器 Front shock absorber

PHOTO	NO.	Part CODE	Chinese/English name and specification	UNIT	QTY	
	1.3	371300-T500-00001	前减震器-左(标准版-渝安减震)	Front shock absorber - Left (Standard version -	PIECE	1
	1.4	371300-T501-00001	前减震器-左(高座版-渝安减震)	Front shock absorber - Left (Yu 'an shock	PIECE	1
	2.3	371400-T500-00001	前减震器-右(标准版-渝安减震)	Front shock absorber - Right (Standard version -	PIECE	1
	2.4	371400-T501-00001	前减震器-右(高座版-渝安减震)	Front shock absorber - right (Yu 'an shock	PIECE	1
	3	5006-04012-SC00	自攻钉ST4.8*12	Self Tapping ST4.8*12	PIECE	2
	4	350035-T501-00000	前制动油管压板	Front brake tubing press plate	PIECE	1
	5	390062-T501-00000	前减震器装饰罩-右	Front shock absorber decoration cover - right	PIECE	1
	6	390055-T501-00000	前减震器装饰罩-左	Front shock absorber decoration cover - left	PIECE	1
	7	5004-06010-BS00	内六角盘头螺钉M6*10	Screw, Inner Hex. Flat Head	PIECE	6
	8	5021-08025-DK00	内六花六角法兰面螺栓M8*25	Bolt, Hex. Flange	PIECE	4
	9	340600-T501-00000	侧反射器	Side Reflector	PIECE	2
	10					
11						
12						
13						
14						

F-28 散热器 Radiator

PHOTO	NO.	Part CODE	Chinese/English name and specification		UNIT	QTY
	1	5021-05012-DK00	内六角六角法兰面螺栓M5*12	Bolt, Hex. Flange M5*12	PIECE	4
	2	300302-T501-00000	散热器格栅-左	Radiator grille. - Left	PIECE	1
	3	300300-T501-00001	散热器总成-左	Radiator Assembly - Left	PIECE	1
	4	420056-T501-00000	水箱连接管	Water tank connection pipe	PIECE	1
	5	300400-T501-00001	散热器总成-右	Radiator Assembly - Right	PIECE	1
	6	300402-T501-00000	散热器格栅-右	Radiator grille. - Right	PIECE	1
	7	300200-T501-00001	储水壶总成	Cooling Tank Assy	PIECE	1
	8	5021-06025-DK00	内六角六角法兰面螺栓M6*25	Bolt, Hex. Flange	PIECE	4
	9	5018-06015-SC00	平垫 $\phi 6.3 * \phi 18 * 1.5$	Washer, Flat	PIECE	2
	10	5004-06012-BS01	内六角台阶螺钉M6*12, 台阶8.5*3.5	Stepping Screw, Inner Hex. M6*12, Stepping	PIECE	2
	11	420020-T501-00000	进水管(左散热器)	Inlet pipe (left radiator)	PIECE	1
	12	420020-T501-00001	进水管(右散热器)	inlet pipe (right radiator)	PIECE	1
	13	420021-T501-00000	出水管	outlet pipe	PIECE	1
	14	420027-T501-00000	泄压管	Pressure Relif Pipe	PIECE	1
	15	420700-T501-00000	储水壶排水管	Drain Pipe, Cooling Tank Assv	PIECE	1
	16					
	17					
	18					
	19					
	20					

F-29 油冷器 Oil cooler

PHOTO	NO.	Part CODE	Chinese/English name and specification		UNIT	QTY
	1	5021-06025-DK00	内六花六角法兰面螺栓M6*25	Bolt, Hex. Flange	PIECE	1
	2	5018-06015-SC00	平垫 $\phi 6.3 * \phi 18 * 1.5$	Washer, Flat	PIECE	1
	3	311600-T501-00000	油冷器 (油管接头M10*1.25, 配4颗M10*1.25*25过油螺栓, 配8个 $\phi 10$ 铜垫圈)	Oil cooler	PIECE	1
	4	420057-T501-00000	油冷器进油管	Oil cooler inlet pipe	PIECE	1
	5	420058-T501-00000	油冷器出油管	Oil cooler outlet pipe	PIECE	1
	6					
	7					
	8					
	9					
	10					
	11					
	12					
	13					
	14					
	15					
	16					
	17					
	18					
	19					
	20					

F-30 消声器 Muffler						
PHOTO	NO.	Part CODE	Chinese/English name and specification		UNIT	QTY
	1	320200-T500-00000	消声器后段总成	Rear Part, Muffler Assy	PIECE	1
	2	5008-08085-SC00	六角法兰面自锁螺母M8	Tapping Nut, Hex. Flange M8*1.25	PIECE	1
	3	5018-08420-SC00	平垫 $\phi 8.4 * \phi 24 * 2$	Washer, Flat	PIECE	1
	4	5021-08045-DK00	内六花六角法兰面螺栓M8*45	Bolt, Hex. Flange	PIECE	1
	5	320800-T500-00001	消声器中段总成	Muffler middle section assembly	PIECE	1
	6	5021-08030-DK00	内六花六角法兰面螺栓M8*30	Bolt, Hex. Flange	PIECE	1
	7	5018-08420-SC00	平垫 $\phi 8.4 * \phi 24 * 2$	Washer, Flat	PIECE	1
	8	420011-T501-00001	消声器安装工字胶24.5*30.5*19	Installment Rubber, Muffler I-Shaped	PIECE	1
	9	5013-15019-YH00	翻边衬套15*8.5*20.5	Bushing, Flange 15*8.5*20.5	PIECE	1
	10	310900-T500-00000	氧传感器	oxygen sensor	PIECE	1
	11	5008-08165-SC00	盖形螺母M8*1.25*14	cap nut M8*1.25*14	PIECE	2
	12	320100-T500-00000	消声器前段总成	Exhausting Pipe, Muffler Assv	PIECE	1
	13	320001-T501-00000	消声器密封垫	Seal Gasket, Muffer Assy	PIECE	1
	14	400006-R100-000	线钩	wire hook	PIECE	1
	15					
	16					
	17					
	18					
	19					
	20					

F-31 前挡风与油箱装饰件 Windshield and fuel tank trim

PHOTO	NO.	Part CODE	Chinese/English name and specification		UNIT	QTY	
	1	5007-06021-HX00	1/4转快锁式螺栓M6*21	1/4Turn fast locking bolt	PIECE	2	
	2	5012-07024-FH00	弹出弹簧 $\phi 7.63 * \phi 11.43 * 24.13$	Pop-up spring $\phi 7.63 * \phi 11.43 * 24.13$	PIECE	2	
	3	5018-07035-BS00	杯形垫圈 $\phi 7 * \phi 24 * 3.5$	cup washer $\phi 7 * \phi 24 * 3.5$	PIECE	2	
	4	5020-05405-BS00	挡圈 $\phi 5.4 * \phi 12.5 * 0.5$	Collar $\phi 5.4 * \phi 12.5 * 0.5$	PIECE	6	
	5	390028-T500-00000	前挡风	front windshield	PIECE	1	
	6	420008-R201-000	工字胶圈2.85+2.6+2.85	Ring, Rubber I-Shaped	PIECE	2	
	7	5028-05013-BS00	内六花台阶螺钉M5*13	Stepping Screw, Inner Hex.	PIECE	6	
	8	5018-08007-BS00	平垫 $\phi 8 * \phi 14 * 0.7$	Flat pad (nylon)	PIECE	6	
	9	420024-R100-000	橡胶螺母	Rubber nut	PIECE	6	
	10	5007-06016-HX00	1/4转快锁式螺栓M6*16	1/4 Quick-lock Bolt	PIECE	4	
	11	5018-06520-BS00	平垫 $\phi 6.5 * \phi 24 * 2$	Washer, Flat $\phi 6.5 * \phi 20 * 2$	PIECE	4	
	12	390076-T500-00000	油箱前装饰件-左	Tank front decoration piece - left	PIECE	1	
	13	390077-T500-00000	油箱前装饰件-右	Tank front decoration piece - right	PIECE	1	
	14	341000-P200-00000	后转向灯-左	Rear Turning Light (Left)	PIECE	1	
	15	341100-P200-00000	后转向灯-右	Rear Turning Light (Right)	PIECE	1	
	16						
	17						
	18						
	19						
	20						

F-32 制动系统-1 Braking system-1

PHOTO	NO.	Part CODE	Chinese/English name and specification	UNIT	QTY
	1	350501-T501-00000	后刹车片 Rear brake pad	PIECE	2
	2	350500-T501-00000	后制动卡钳总成 Rear brake caliper assembly	PIECE	1
	3	5005-05012-HX00	十字大盘头螺钉M5*12 Screw, Cross-Shaped, Cup Head M5*12	PIECE	4
	4	350025-T501-00001	油管卡子 Oil pipe clip	PIECE	2
	5	350002-R100-000	铜垫圈 $\phi 10 * \phi 15 * 1.5$ Copper Washer $\phi 10 * \phi 15 * 1.5$	PIECE	14
	6	350800-T500-00000	制动油管1(前制动泵连ABS) Brake Tubing 1(front brake pump with ABS)	PIECE	1
	7	350001-R100-000	过油螺栓 Oil Bolt	PIECE	3
	8	350900-T500-00001	制动油管2(前卡钳连ABS) Brake Tubing 2(Front caliper with ABS)	PIECE	1
	9	5021-08035-SC00	内六角六角法兰面螺栓M8*35 Bolt, Hex. Flange	PIECE	2
	10	350301-T501-00000	前刹车片 Front brake pads	PIECE	2
	11	352600-T501-00000	前制动卡钳总成 Front brake caliper assembly	PIECE	1
	12	350001-R100-001	过油螺栓 Oil Bolt	PIECE	4
	13	351000-T500-00000	制动油管3(后制动泵连ABS) Brake Tubing 3(rear brake pump with ABS)	PIECE	1
	14	5004-06016-BS00	内六角大盘头螺钉M6*16 Screw, Inner Hex. Flat Big Head	PIECE	2
	15	350600-T501-00000	后制动泵总成 Rear brake pump assembly	PIECE	1
	16	350033-T501-00000	后制动泵销轴 Rear brake pump pin	PIECE	1
	17	350034-T501-00000	后制动泵拨叉 Rear brake pump fork	PIECE	1
	18	5018-08012-BS00	平垫 $\phi 8 * \phi 16 * 1$ washer, flat $\phi 8 * \phi 16 * 1$	PIECE	1
	19	5015-01016-SC00	开口销1.2*16 Pin, Split 1.2*16	PIECE	1
	20	351100-T500-00000	制动油管4(后卡钳连ABS) Brake Tubing 4(Rear caliper with ABS)	PIECE	1

F-32 制动系统-2 Braking system-2

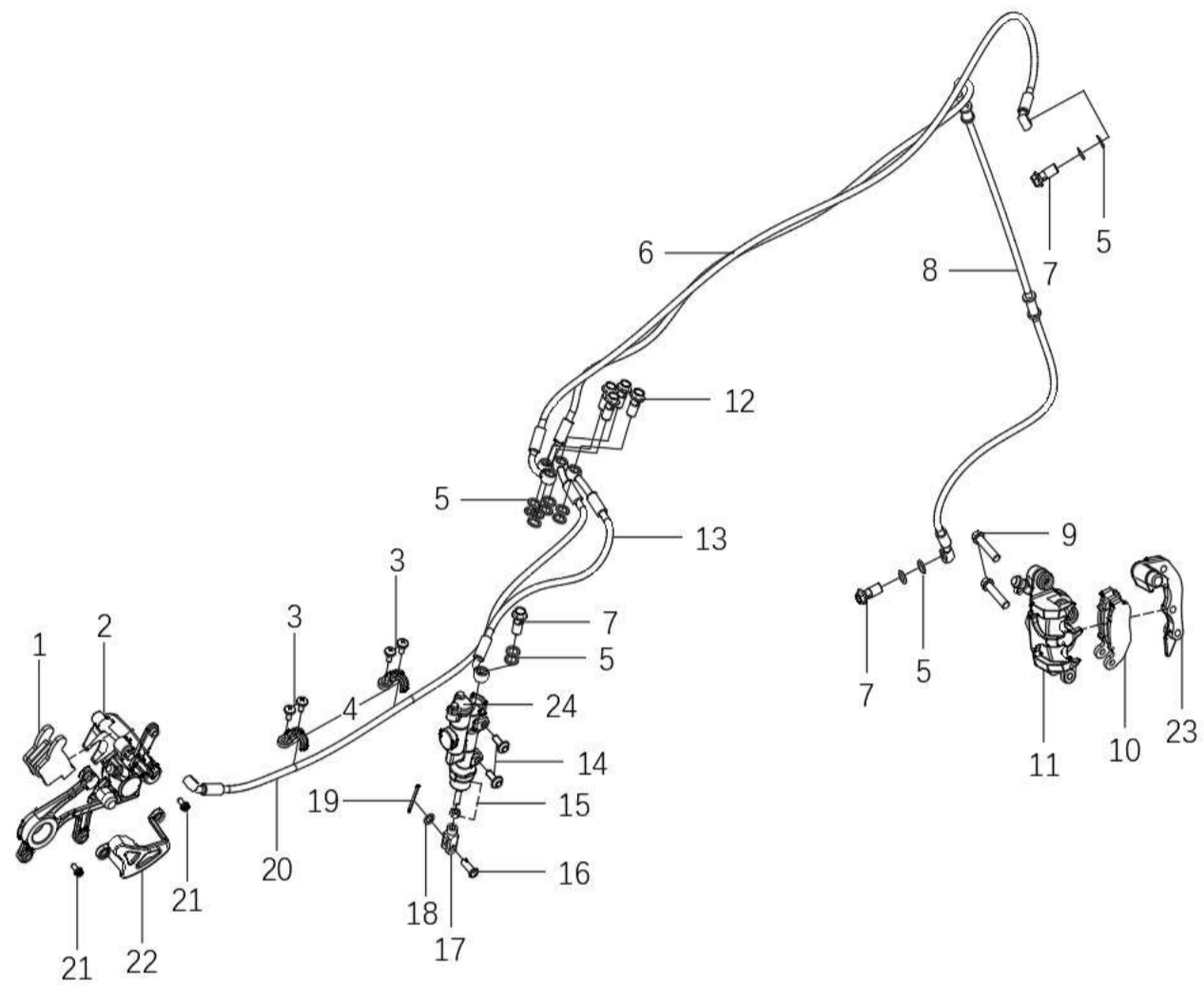
PHOTO	NO.	Part CODE	Chinese/English name and specification	UNIT	QTY	
	21	5021-06012-DK00	内六花六角法兰面螺栓M6*12 Bolt, Hex. Flange M6*12	PIECE	2	
	22	390080-T501-00000	后制动卡钳装饰件 Rear brake caliper decoration piece	PIECE	1	
	23	350036-T501-00000	前卡钳支架 Front caliper bracket (for KYB shock	PIECE	1	
	24	350602-T501-00000	后制动泵油杯盖 oil cup cover, Rear brake pump	PIECE	1	
	25					
	26					
	27					
	28					
	29					
	30					
	31					
	32					
	33					
	34					
	35					
	36					
	37					
	38					
	39					
	40					

F-33 前脚蹬 Front pedal

PHOTO	NO.	Part CODE	Chinese/English name and specification		UNIT	QTY
	1	370400-T501-00000	前脚蹬-右	Front pedal. - Right	PIECE	1
	2	370014-T501-00002	销 ϕ 2	Pin	PIECE	2
	3	370300-T501-00000	前脚蹬-左	Front pedal. -Left	PIECE	1
	4	370004-T501-00000	脚蹬扭簧-右	Foot twist spring. - Right	PIECE	1
	5	370003-T501-00000	脚蹬扭簧-左	Foot twist spring. - Left	PIECE	1
	6	5018-10515-LB00	平垫 ϕ 10.5* ϕ 20*1.5	washer flat ϕ 10.5* ϕ 20*1.5	PIECE	2
	7	5015-01016-SC00	开口销1.2*16	Pin, Split 1.2*16	PIECE	2
	8					
	9					
	10					
	11					
	12					
	13					
	14					
	15					
	16					
	17					
	18					
	19					
	20					

F-34 侧支架 Side stand						
PHOTO	NO.	Part CODE	Chinese/English name and specification	UNIT	QTY	
	1	360057-T501-00000	侧支架安装挂板 Side Stand mounting pendant plate	PIECE	1	
	2	5008-10115-SC00	六角法兰面自锁螺母M10*1.25 Tapping Nut, Hex. Flange M10*1.25	PIECE	1	
	3.1	370013-T500-00000	侧支架(标准版-KYB减震-渝安减震) Side stand (Standard version -KYB damping -	PIECE	1	
	3.2	370013-T501-00001	侧支架(高座版-KYB减震-渝安减震) Side Stand	PIECE	1	
	4	5007-10042-SC00	侧支架专用螺栓 Bolt, Side Stand	PIECE	1	
	5	360020-T501-00000	侧支架簧 $\phi 15*110$, 线径2.5mm Spring, Side Stand $\phi 15*110$, Line Diameter 2.5mm	PIECE	1	
	6	360020-T501-00001	侧支架簧 $\phi 9.5$, 线径1.6mm Spring, Side Stand $\phi 9.5$, Line Diameter 1.6mm	PIECE	1	
	7					
	8					
	9					
	10					
	11					
	12					
	13					
	14					
	15					
	16					
	17					
	18					
19						

F-35 头罩支架 Hood bracket

PHOTO	NO.	Part CODE	Chinese/English name and specification	UNIT	QTY
	1	5005-05020-SC00	十字盘头螺钉M5*20 Screw, Inner Hex. Flat Head M5*20	PIECE	4
	2	5018-05515-SC00	平垫 φ5 Washer, Flat φ5	PIECE	4
	3	420008-R201-000	工字胶圈 Ring, Rubber I-Shaped	PIECE	4
	4	5013-06008-SC01	翻边衬套 φ6*φ9*φ18*8.5 Bushing, Flange	PIECE	4
	5	5021-05012-DK00	内六花六角法兰面螺栓M5*12 Bolt, Hex. Flange M5*12	PIECE	8
	6	5001-08020-SC00	内六花六角法兰面螺栓M8*20 Bolt, Hex. Flange	PIECE	4
	7	360060-T500-00000	挡线板 Wire stopper	PIECE	1
	8	421000-R100-000	膨胀胶钉 Rubber Nail, Expansion	PIECE	2
	9	360058-T500-00000	头罩支架-左 Hood bracket. - Left	PIECE	1
	10	360059-T500-00000	头罩支架-右 Hood bracket. - Right	PIECE	1
	11				
	12				
	13				
	14				
	15				
	16				
	17				
	18				
	19				
	20				